



■ Features :

- Universal AC input / Full range
- Protections: Short circuit / Overload / Over voltage
- Cooling by free air convection
- LED indicator for power on
- 100% full load burn-in test
- All using 105°C long life electrolytic capacitors
- Withstand 300VAC surge input for 5 second
- High operating temperature up to 70°C
- Withstand 5G vibration test
- No load power consumption<0.5W
- High efficiency, long life and high reliability
- 3 years warranty



SPECIFICATION

MODEL	RS-50-3.3	RS-50-5	RS-50-12	RS-50-15	RS-50-24	RS-50-48	
OUTPUT	DC VOLTAGE	3.3V	5V	12V	15V	24V	48V
	RATED CURRENT	10A	10A	4.2A	3.4A	2.2A	1.1A
	CURRENT RANGE	0 ~ 10A	0 ~ 10A	0 ~ 4.2A	0 ~ 3.4A	0 ~ 2.2A	0 ~ 1.1A
	RATED POWER	33W	50W	50.4W	51W	52.8W	52.8W
	RIPPLE & NOISE (max.) Note.2	80mVp-p	80mVp-p	120mVp-p	120mVp-p	120mVp-p	200mVp-p
	VOLTAGE ADJ. RANGE	3V ~ 3.6V	4.75 ~ 5.5V	10.8 ~ 13.2V	13.5 ~ 16.5V	22 ~ 27.2V	42 ~ 54V
	VOLTAGE TOLERANCE Note.3	±3.0%	±2.0%	±1.0%	±1.0%	±1.0%	±1.0%
	LINE REGULATION Note.4	±0.5%	±0.5%	±0.5%	±0.5%	±0.5%	±0.5%
	LOAD REGULATION Note.5	±2.0%	±1.0%	±0.5%	±0.5%	±0.5%	±0.5%
	SETUP, RISE TIME	500ms, 30ms/230VAC 1200ms, 30ms/115VAC at full load					
HOLD UP TIME (Typ.)	60ms/230VAC 14ms/115VAC at full load						
INPUT	VOLTAGE RANGE	88 ~ 264VAC 125 ~ 373VDC (Withstand 300VAC surge for 5sec. Without damage)					
	FREQUENCY RANGE	47 ~ 63Hz					
	EFFICIENCY(Typ.)	78%	83%	84.5%	86%	88%	89%
	AC CURRENT (Typ.)	1.3A/115VAC 0.8A/230VAC					
	INRUSH CURRENT (Typ.)	COLD START 33A/230VAC					
	LEAKAGE CURRENT	<2mA / 240VAC					
PROTECTION	OVERLOAD	110 ~ 150% rated output power Protection type : Hiccup mode, recovers automatically after fault condition is removed					
	OVER VOLTAGE	3.8 ~ 4.45V	5.75 ~ 6.75V	13.8 ~ 16.2V	17.25 ~ 20.25V	27.6 ~ 32.4V	55.2 ~ 64.8V
ENVIRONMENT	WORKING TEMP.	-25 ~ +70°C (Refer to "Derating Curve")					
	WORKING HUMIDITY	20 ~ 90% RH non-condensing					
	STORAGE TEMP., HUMIDITY	-40 ~ +85°C, 10 ~ 95% RH					
	TEMP. COEFFICIENT	±0.03%/°C (0 ~ 50°C)					
	VIBRATION	10 ~ 500Hz, 5G 10min./1cycle, period for 60min. each along X, Y, Z axes					
SAFETY & EMC (Note 6)	SAFETY STANDARDS	UL60950-1, TUV EN60950-1, CCC GB4943 approved					
	WITHSTAND VOLTAGE	I/P-O/P:3KVAC I/P-FG:2KVAC O/P-FG:0.5KVAC					
	ISOLATION RESISTANCE	I/P-O/P, I/P-FG, O/P-FG:100M Ohms / 500VDC / 25°C/ 70% RH					
	EMC EMISSION	Compliance to EN55022 (CISPR22) Class B, EN61000-3-2,-3,GB9254 class B,GB17625.1					
	EMC IMMUNITY	Compliance to EN61000-4-2,3,4,5,6,8,11; EN61000-6-2 (EN50082-2), heavy industry level, criteria A					
OTHERS	MTBF	228Khrs min. MIL-HDBK-217F (25°C)					
	DIMENSION	99*97*36mm (L*W*H)					
	PACKING	0.41Kg; 45pcs/19.5Kg/0.9CUFT					
NOTE	<ol style="list-style-type: none"> 1. All parameters NOT specially mentioned are measured at 230VAC input, rated load and 25°C of ambient temperature. 2. Ripple & noise are measured at 20MHz of bandwidth by using a 12" twisted pair-wire terminated with a 0.1uF & 47uF parallel capacitor. 3. Tolerance : includes set up tolerance, line regulation and load regulation. 4. Line regulation is measured from low line to high line at rated load. 5. Load regulation is measured from 0% to 100% rated load. 6. The power supply is considered a component which will be installed into a final equipment. All the EMC tests are been executed by mounting the unit on a 360mm*360mm metal plate with 1mm of thickness. The final equipment must be re-confirmed that it still meets EMC directives. For guidance on how to perform these EMC tests, please refer to "EMI testing of component power supplies." (as available on http://www.meanwell.com) 						

■ Mechanical Specification

Case No. 905B Unit:mm

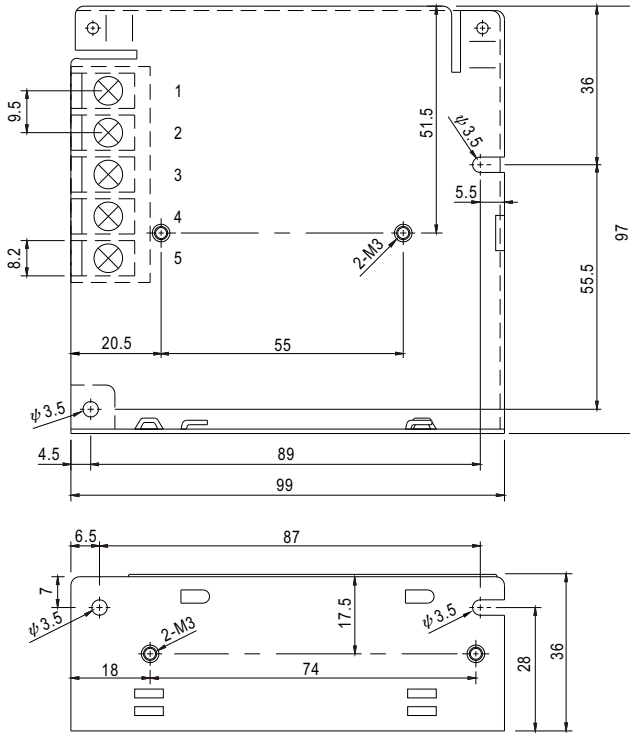

Terminal Pin No. Assignment

Pin No.	Assignment	Pin No.	Assignment
1	AC/L	4	DC OUTPUT -V
2	AC/N	5	DC OUTPUT +V
3	FG \perp		

■ Block Diagram

fosc : 60KHz

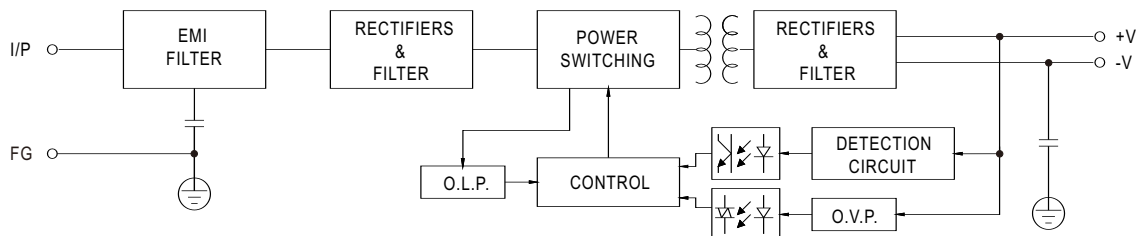

■ Derating Curve

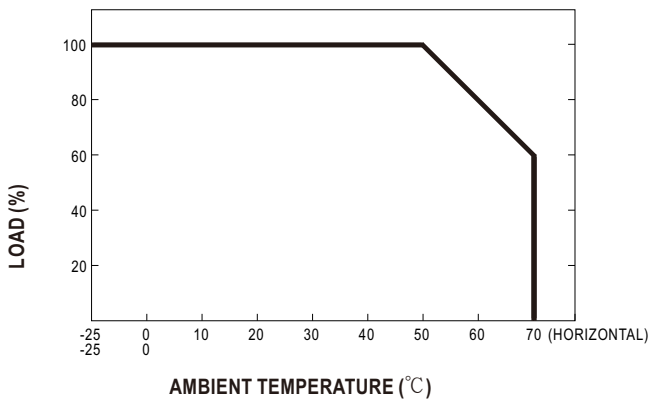

■ Output Derating VS Input Voltage

